

11.CAUTION

1. When the temperature is too high, HI will be displayed in the temperature area to express the room temperature over the display range. When the temperature is too low, LO will be displayed in the emperature area to express the room temperature blow the display range.
2. Within 1hour after power off, time and week will keep running.
3. There is preservative on the LCD when out of the factory, users can remove it or not.
4. If you need to remove the preservative, just pull it from the corner and no need to open the thermostat.
5. Don't force to install. When it is hard to connect the pin, move the display panel slightly. After the pin aimed at the port, press the thermostat hard.
6. It is precision electronic products. Don't knock or fall it.
7. Don't let the water, mud into the thermostat.

12.Notes for touch screen

1. Please don't touch the screen when the oil or the water stainson your hands.
2. If the screen is stained by water or dusty, it will reduce the .sensitivity, even result the touch screen failure.
3. Please use the soft cloth to clean the touch screen.
4. Please don't operate the touch screen with hard objects, toprevent scratching the surface.

13.SPECIFICATIONS

- the display range of temperature.....44°F to 90°F (7°C to 32°C)
 the control range of temperature.....44°F to 90°F (7°C to 32°C)
 Load rating.....1 amp per terminal, 1.5 amp maximum all terminals combined
 Display accuracy± 0.5°C
 Power source.....18 to 30 VAC, NEC Class II, 50/60 Hz for hardwire (common wire)
 Operating ambient.....41°F to +95°F(5°C to +35°C)
 Operating humidity.....90% non-condensing maximum
 Dimensions of thermostat.....118mm*86mm*27mm

Name: QUNDA Control Technology (Jiangsu) Co., Ltd.
 Address: No.888 LongQiao Road, WuJiang District,
 SuZhou, China
 Post code: 215200 Web site: www.qunda.com



INSTALLATION MANUAL



QD-HVAC15 WIFI

Touch-Screen Programmable Thermostat

Table of Contents	Page
Preface	1
Production Function Overview	1
Diagram and Description	2~3
Wall locations	4
Subbase Installation	5
WIRING	6
Wiring Diagrams	7
Operation	8~10
Mount Thermostat	11
Caution	12
Notes for touch screen	12
Specifications	12

1.Preface

Dear client:
 Thanks for choosing QD-HVAC15 WIFI thermostat series. It's our best wish to bring you convenience for your daily life. Before using, please read the User's Manual carefully. It will help you to use it correctly.

2.Production Function Overview

2.1 Application

Description	
1 stage Heat and 1 stage Cool	Yes
Gas or Oil Heat	Yes
Electric Furnace	Yes
Heat Pump(NO Aux. or Emergency Heat)	Yes
Heat Only Systems	Yes
Heat Only Systems - Floor or Wall Furnaces	Yes
Cool Only Systems	Yes
Millivolt	Yes

2.2 Feature

- Be able to operate your air conditioner whenever and wherever you are with your mobile phone.
- Mobile phone control and suitable for Android & IOS system.
- Programmable thermostat
- 5+2 Programmable
- Easy to program
- Easy to install
- 7 square inch display
- Full and touch screen
- 24V Hardwire
- Operate on 1 stage Heat and 1 stage cool
- Heat Pump without Aux or Emergency Heat
- Separate heating and cooling swing(cyclerate) adjustments
- 5 minutes compressor delay protection (selectable on or off)
- Gas, Electric or Oil
- Optional temperature display of Fahrenheit or Celsius scale.
- Display temperature calibration



A trained, experienced technician must install this product.

Carefully read these instructions. You could damage this product or cause a hazardous condition if you fail to follow these instructions.

3. Diagram and Description

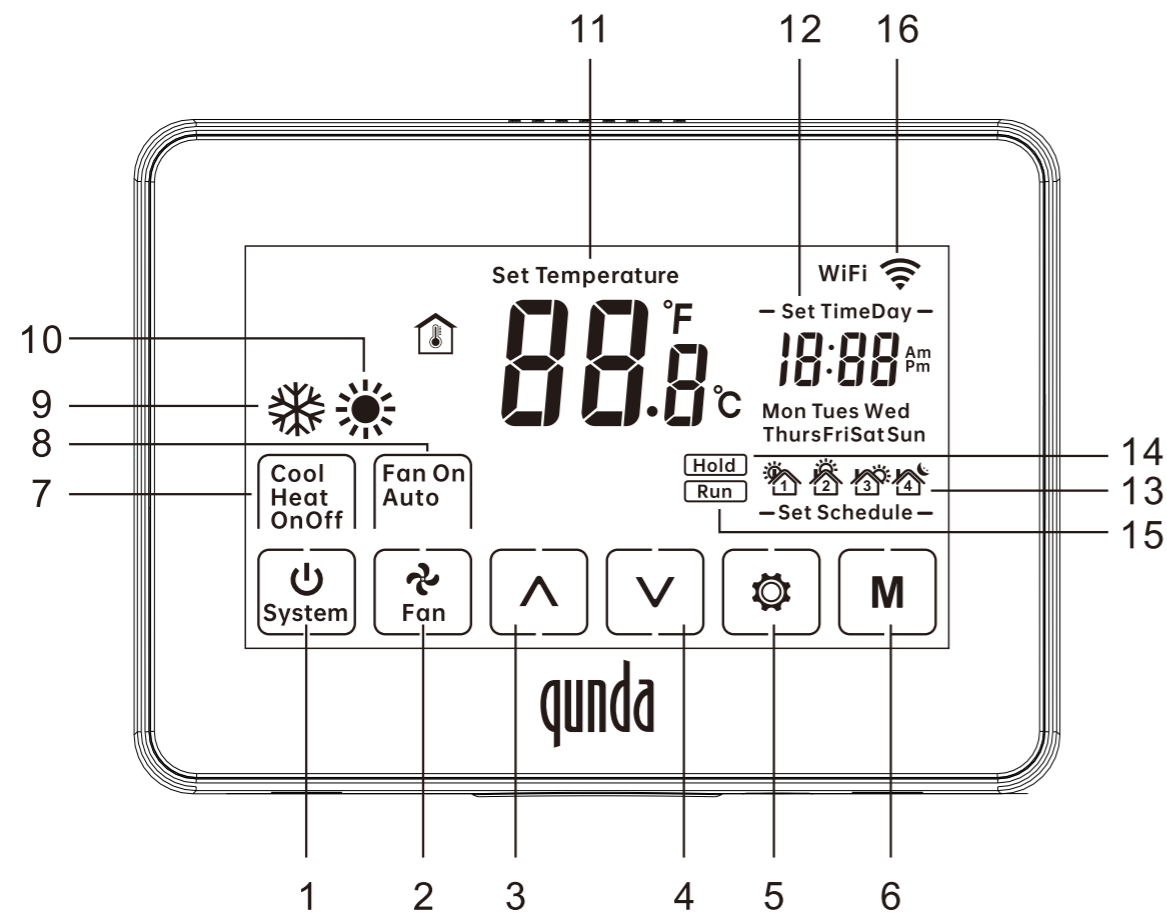

Item	Description
1	Mode key: First press for cool mode, and second is for heat mode. Press again will turn off the thermostat.
2	Fan mode: in the cooling/heating mode, switch the fan between on and auto.
3	Up key: in the cooling/heating mode, it is for raising the setting temperature. When setting the program and changing the system parameter, it is for adjusting the parameter.
4	Down key: in the cooling/heating mode, it is for lowering the setting temperature. When setting the program and changing the system parameter, it is for adjusting the parameter.

5	Hold/Set key: Press only once, the LCD display "hold", and the thermostat keeps the current mode and setting temperature. In the cool/heat mode, press it to keep the setting temperature, and the setting temperature will not change in the setting process. In the cool/heat mode, press and hold the key for 3 seconds to enter the setting interface. When power off, hold the key for 5 seconds to enter the parameter changing interface.
6	Run key: Press only once, the thermostat operates according to the time programming. After setting the program and changing the system parameter, press the run key to save and exit the setting interface.
7	Cool symbol/Heat symbol: The cooling relay start to work when the cool symbol displayed. The cool symbol flashing means the cooling relay is in the set-up delay process. The heating relay start to work when the heat symbol displayed. The symbol flashing means the heating relay is in the set-up delay process.
8	Fan: display the current mode of the fan.
9	System cool: The symbol displayed means it is in the cooling mode.
10	System heat: The symbol displayed means it is in the heating mode.
11	Temperature: Display the room temperature or setting temperature.
12	Clock/Week: Display the current system time and week.
13	Program setting: it shows the system is in the setting process. 🏠 appears, it means to set the wake time and temperature. 🏠 appears, it means to set the leave time and temperature. 🏠 appears, it means to set the return time and temperature. 🏠 appears, it means to set the wake time and temperature.
14	Hold symbol: when the symbol displayed, the setting temperature will be kept and won't follow the setting program.
15	Run symbol: when the symbol displayed, the setting temperature will follow the setting program.
16	WiFi symbol: Symbol flashes, means to configure the network Symbol always on, means connected the network

4. Wall locations

The thermostat should be installed approximate 4 to 5 feet above the floor. Select an area with average temperature and good air circulation.

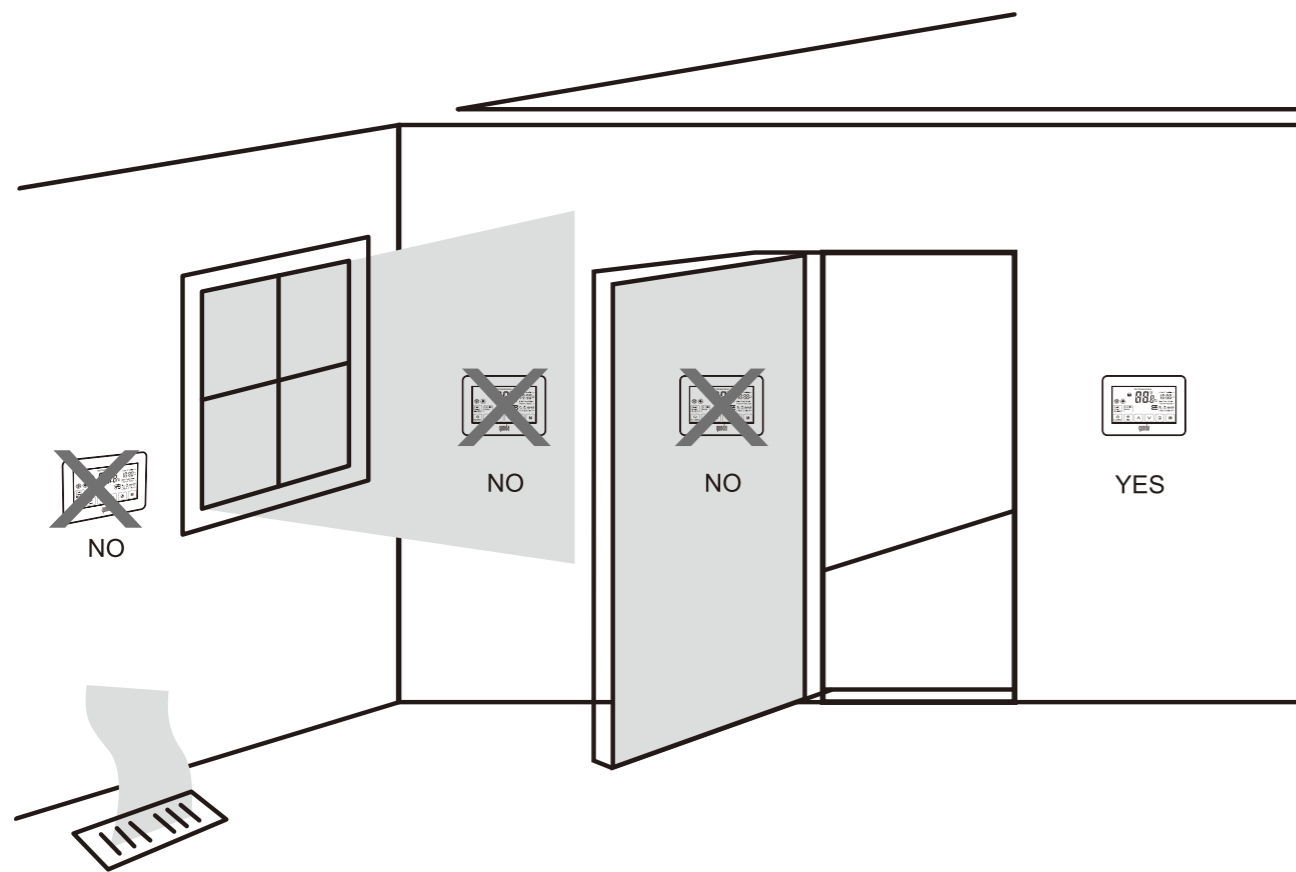

Do not install thermostat at following places:

- Close to hot or cold air ducts
- With direct sunlight
- With an outside wall behind the thermostat
- The areas that do not require conditioning
- Where there are dead spots or drafts (in corners or behind doors)
- Where there might be concealed chimneys or pipes

Installation Tip

Pick an installation location that is easy for the user to access. The temperature of the location should be representative of the building.

5. SUBBASE INSTALLATION



Caution: Electrical Hazard

Failure to disconnect the power before beginning to install this product can cause electrical shock or equipment damage.



Caution: Equipment damage hazard

Do not operate the cooling system if the outdoor temperature is below 50° F (10° C) to prevent possible compressor damage.

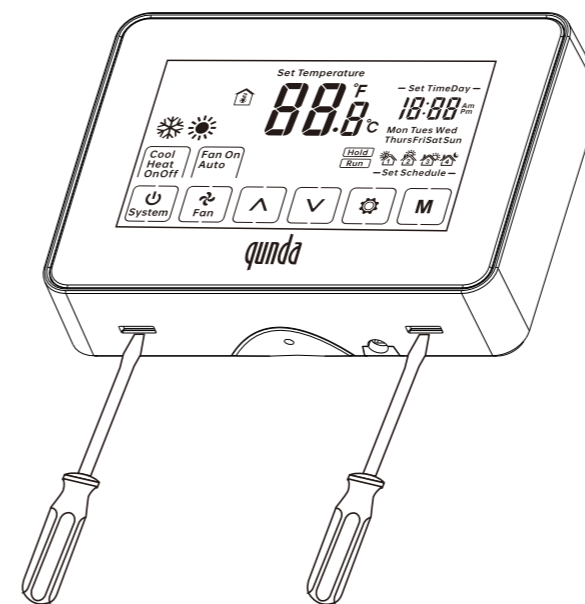

Insert the awl into the slot and pry up the front part of the panel to open it.

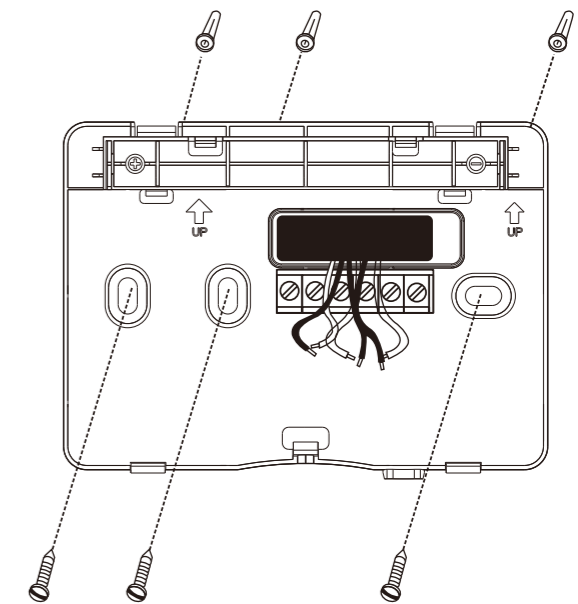

For horizontal mount put one screw left and one screw right.



Caution: Electrical Hazard

Failure to disconnect the power before beginning to install this product can cause electrical shock or equipment damage.



Warning :

All components of the control system and the thermostat installation must conform to Class II circuits per the NEC Code.



Caution:

Do not over tighten terminal block screws, as this can damage terminal block, and keep the thermostat fitting on the sub-base correctly or it will cause system operation issues.

Max Torque = 6in-lbs

Wiring

- 1.If you are replacing a thermostat. Take notice of the terminal connections on the cases, the wiring connections may not be color coded. For example, the green wire may not be connected to the G terminal.
- 2.Loosen the terminal block screws. Insert wires then retighten terminal block screws.
- 3.Place nonflammable insulation into wall opening to prevent drafts.

Terminal Designation

- C Common wire from secondary side of cooling system transformer
- O Heat pump changeover valve energizes in cooling
- B Heat pump changeover valve energizes in heating
- W Heat relay

- RH Transformer power for heating
- RC Transformer power for cooling
- G Fan relay
- Y Compressor relay

Wiring Tips:

RH & RC terminals

For single transformer systems, leave the jumper wire in place between RH and RC. Remove jumper wire for two transformer systems.

Wire specifications

Use shielded or non-shielded 18 - 22 gauge thermostat wire.

- 1 Power supply
- 2 Factory-installed jumper. Remove only when installing on 2-transformer systems
- 3 In heat pump mode, please check the reversing valve to see whether it is in **O** or **B** position, and enter the system to set reversing valve to the position you need.
- 4 The system is in the electronic mode in default setting. If the system is gas or oil supported, enter the setting interface to set it in the gas mode.

Typical 1H/1C system: 1 transformer

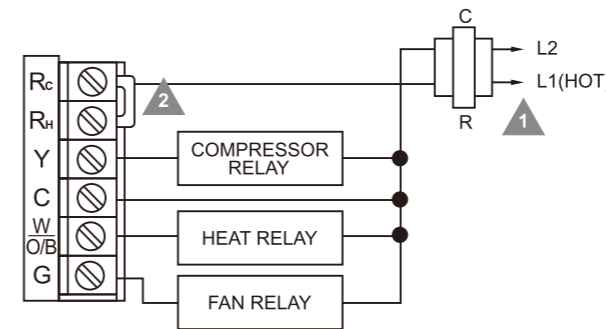

Typical 1H/1C system: 2 transformer

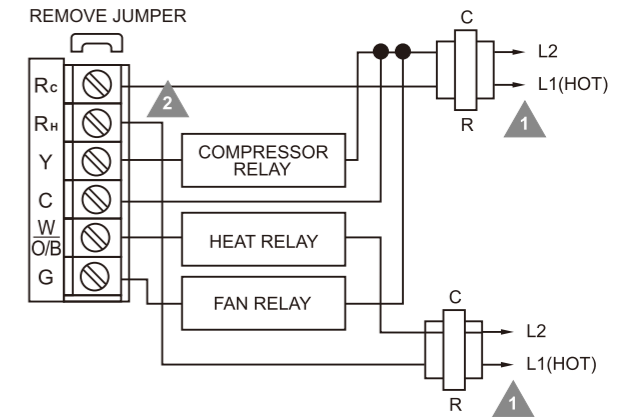

Typical 1H/1C heat pump system

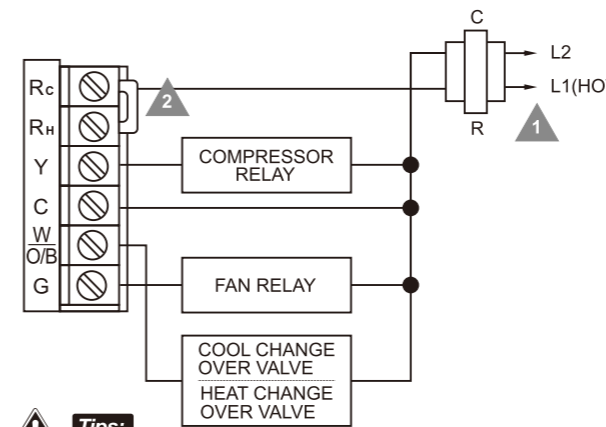

Tips:

- 1.Please set on the heat pump system first.
- 2.Please set the valve as heating/cooling system.

Typical heat-only system

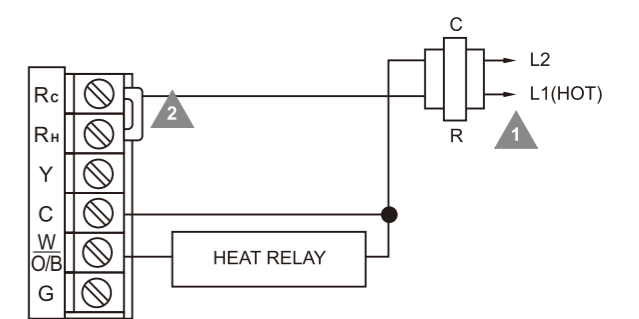



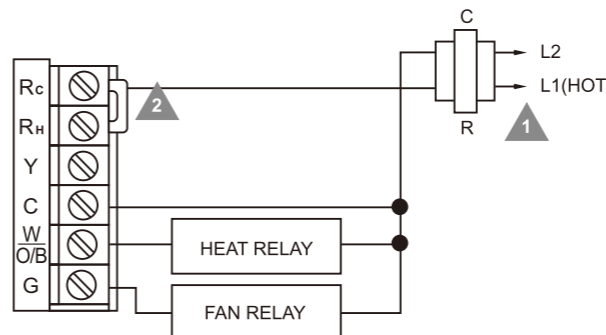



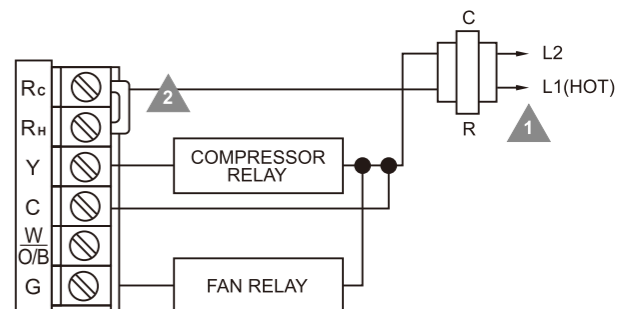



Typical heat-only system with fan



Typical cool-only system





















8.1 Operation









- (1)  : press the “  ” key once to turn on the system. The mode is cool and “  ” is displayed. Meanwhile the room temperature, clock will be also displayed. Change to the heat mode by the second pressing and “  ” is displayed. Press again to turn off the system.
- (2) Setting temperature: when power on, press “  ” or “  ” to set the temperature. Press “  ” to lower the setting temperature, and press “  ” to raise the setting temperature.
- (3)  : When power on, press it to choose the fan on, and press again to change the fan to auto mode.
- (4) **M** : When power on, press the key to run the program what has been set. Meanwhile “ Run ” is displayed. In the programming mode or changing the system parameter, press “ **M** ” to exit and save the changed parameter.
- (5)  : When power on, press the hold key to keep the setting temperature. It won't run the program and display hold. For example: now the setting temperature is 60°F, after pressing the key, the system will lock the setting temperature to be 60°F.

8.2 Programming setting

When power on(in cool/heat mode),hold “  ” for 3 seconds to enter the programming mode:



- (1) First is to set the system clock. When the clock area is flashing, press “  ” or “  ” to change the clock. And if you hold “  ” or “  ” , the adjustment will be faster.
- (2) Press “  ” again to set the week. When the week flashing, press “  ” or “  ” to change the week.
- (3) Press “  ” again to set the Wake time  for Monday. When the clock area is flashing, press “  ” or “  ” to adjust the time.
- (4) Press “  ” again to set the Wake temperature  for Monday When the room temperature area is flashing, press “  ” or “  ” to adjust the temperature.
- (5) Repeat pressing the “  ”, then you can set the time and temperature of Leave  , Return  , Sleep  , from Monday to Friday and Saturday, Sunday by turn.
- (6) After finished the setting, press the “ **M** ” to cancel the setting interface and save the parameter. (if there's no any operation within 30 seconds when setting, the system will exit the setting interface and abandon the changed parameter.)

EXAMPLE: Heating/Cooling Schedule Plan(Factory default program setting)













		Everday	
Mode	Period	Start Time	Temperature
Heat	Wake 	6:00 AM	21°C
	Leave 	8:00 AM	17°C
	Return 	6:00 PM	21°C
	Sleep 	10:00 PM	17°C
Cool	Wake 	6:00 AM	24°C
	Leave 	8:00 AM	28°C
	Return 	6:00 PM	24°C
	Sleep 	10:00 PM	26°C

8.3 System parameter setting

When power off, hold “  ” key for 5 seconds to enter the parameter changing interface.

Room temperature area displays each symbol of the parameter, and system clock area displays each parameter of the parameter values.Repeat to press “  ” key to cycling display the each parameter. Press “  ” or “  ” to adjust each parameter. After finished changing, press “ **M** ”key to exit the setting interface and save the set parameter.

(if there's no any operation within 30 seconds when setting, the system will exit the setting interface and abandon the changed parameter.)

Step	Press Buttons	Display(Factory Defaults)	Press  or  to select	Default parameters	Description
01	 5 seconds	CC	FA or SL	FA	Select fast cooling or slow cooling
02		HC	FA or SL	FA	Select fast heating or slow heating
03		FC	F or C	C	Select °F or °C Readout
04		CP	0 or 5	5	Compressor Lockout delay time 0 = none ; 5 = Minutes
05		CA	-5° to +5°	0	room temperature error correction
06		HP	1 or 0	0	conventional heat pump selection 0: conventional mode 1: heat pump mode
07		Ob	O or b	O	Select cool/heat change over valve "b" = heat change over valve "O" =cool change over valve
08		IC	1 or 0	0	Intelligent Recovery Option "1" = Active "0" =Deactivated
09		6E	E or 6	E	"E"=Electric "6"=Gas
10		bS	S or b	b	S:backlight always be on b:backlight will get dark
11	M	RETURNS TO NORMAL OPERATION			

01 Select cooling cycle rate : CC

The **FA** setting is used to produce shorter cooling cycles. The **SL** setting produces a longer cooling cycle. Both settings produce very accurate temperature control and can be set to your personal preference.

02 Select heating cycle rate : HC

The **FA** setting is used to produce shorter heating cycles. The **SL** setting produces a longer heating cycle. Both settings produce very accurate temperature control and can be set to your personal preference.

03 Select °F or °C readout : FC

Changes the display readout to Centigrade or Fahrenheit as required. The default setting is “°C”.

04 Select compressor lockout delay : CP

To protect the compressor from short cycling, you can select compressor off-time cycle between **0** or **5** minutes. When the thermostat compressor time delay occurs, the **Cool On** or **Heat On** display will flash during compressor lockout. The default setting is “5”.

05 Select temperature recalibration : CA

This feature allows you to adjust the displayed room temperature up to 5° higher or lower. Your thermostat can be accurately calibrated to match your previous thermostat. The current or adjusted room temperature will be displayed on the display. The default setting is “0”.

06 Choose traditional mode or heat pump mode : HP

Users can choose traditional mode or heat pump mode according to your own condition. When heat pump mode is set, the compressor will be enforced 5 minutes delay to restart.

07 Choose the reversing valve of the heat pump : 0b

Users can choose the reversing valve working on the heat mode or the cool mode. In heat pump mode, please check the reversing valve to see whether it is in O or B position, and enter the system to set reversing valve to the position you need.

08 Intelligent Recovery Option : IC

The thermostat has an intelligent recovery function that brings your room temperature at exactly the pre-set time by turning on the Heating earlier. Select **1** to activate the intelligent recovery function, Select **0** to deactivate the intelligent recovery function. The default setting is “0”.



09 Heat fan control : 6E

This function is the control and choosing for the heat fan. If the user uses the Gas or Oil heating system, please choose "**Gas**"(system controls fan operation).If the user uses the Electric heating system, please choose "**Electric**"(thermostat controls fan operation)

10 choose the backlight mode : bS

Users can choose backlight mode. The backlight is always on, when chose "s",The backlight will get dark, when chose "b".The default setting is "b".

8.4 Restore factory settings

When power off, hold “” key for 8 seconds. Symbol “” displayed in the temperature area shows restoring factory setting is successful, and press “**M**” key to exit.

Connect your phone to the WIFI internet, and download Smart Life  from APP market. Then register according to the hint.

9.1 Network configuration(EZ mode).

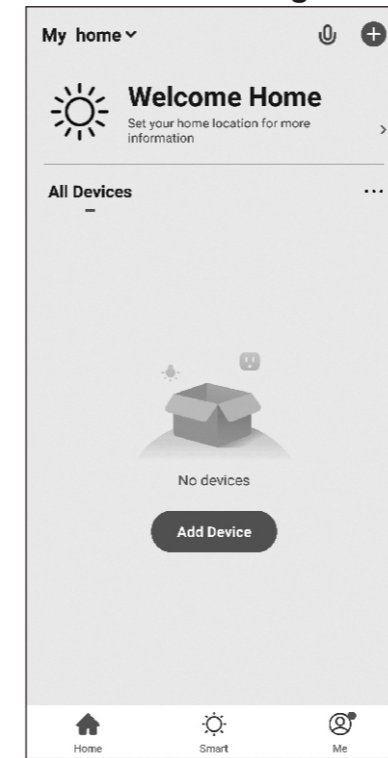

9.1.1 Click + at the upper right corner or add device.

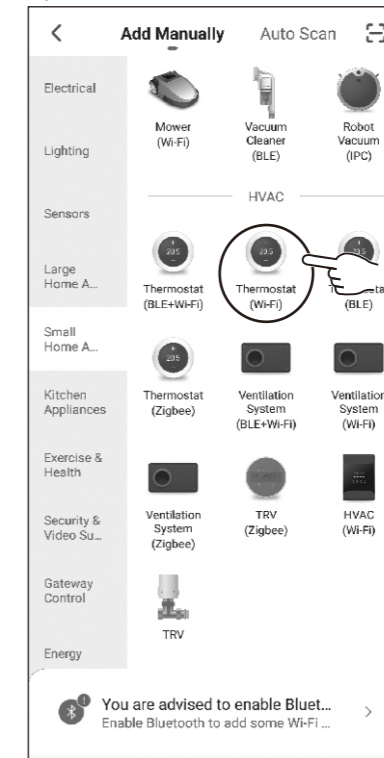

9.1.2 Choose the thermostat on the list of home appliances.

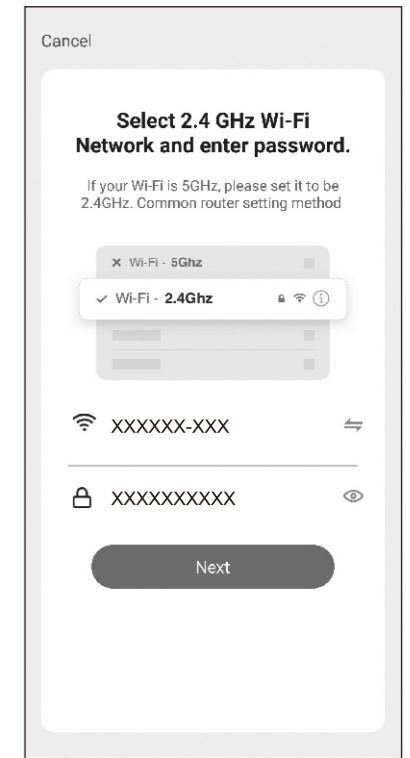

9.1.3 Choose WIFI and enter the correct password, then click the next step.

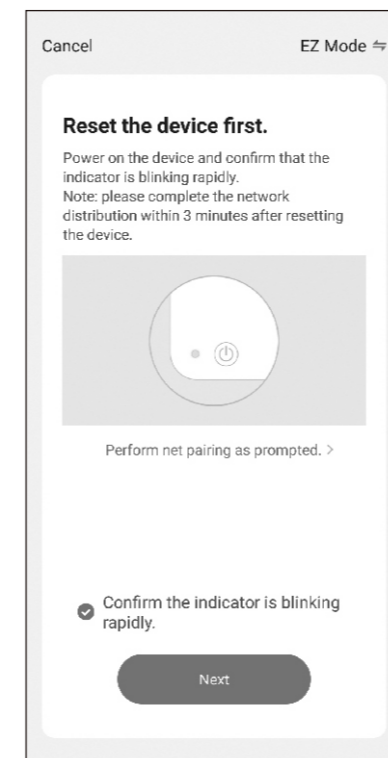

9.1.4 Long press the M key, hold it until the WIFI symbol flashes at the upper right corner of the screen.

9.1.5 Click confirm and the next step.



9.1.6 Enter EZ mode and wait.



9.1.7 Indicate the successful connection, then click Done.

9.2 Network configuration(AP mode).

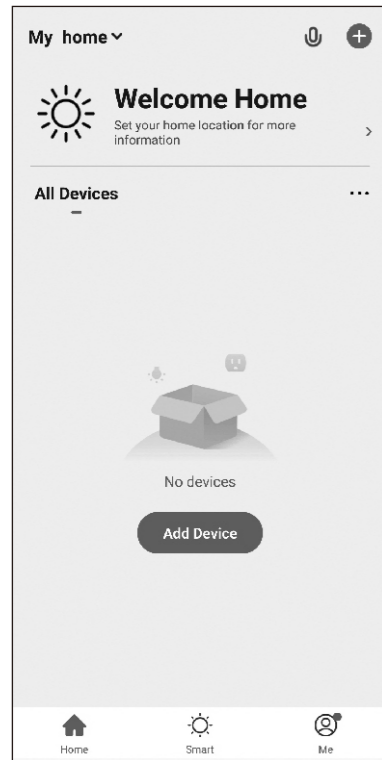

9.2.1 Click + at the upper right corner or add device.

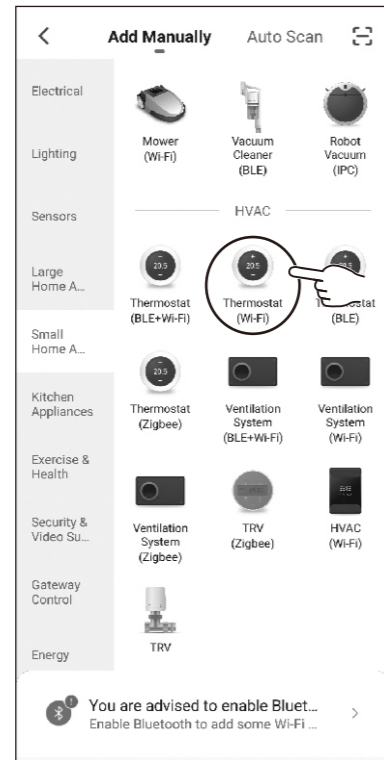

9.2.2 Choose the thermostat on the list of home appliances.

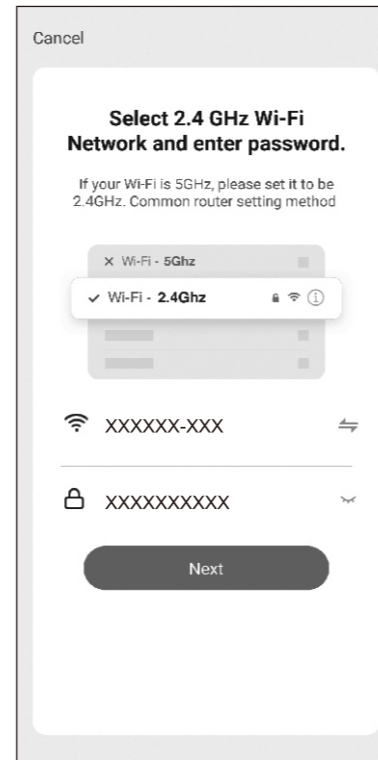

9.2.3 Choose WIFI and enter the correct password, then click the next step.

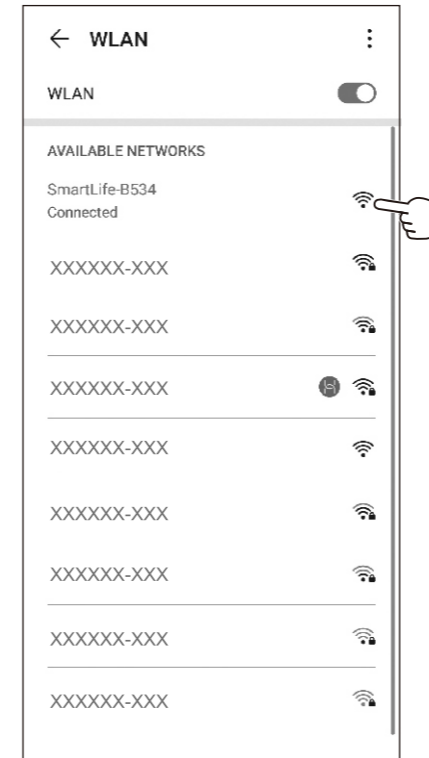

9.2.8 Find the corresponding SmartLife-XXXX or SL-XXXX and connect it.

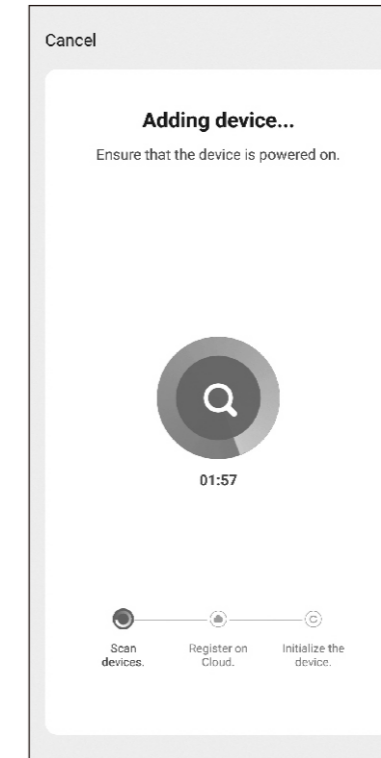

9.2.9 Return to the network configuration interface.

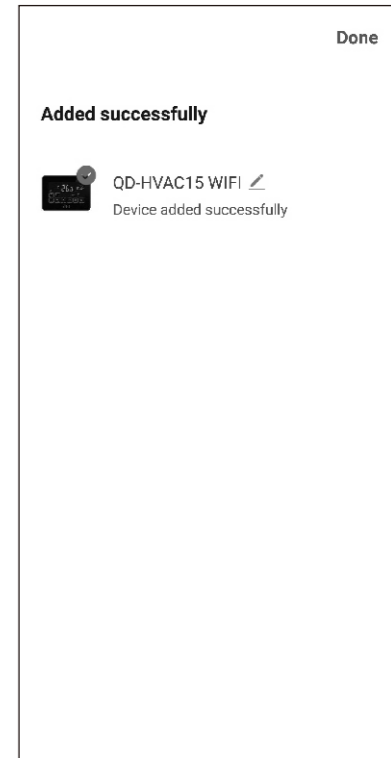

9.2.10 Success configuring the internet, click Done

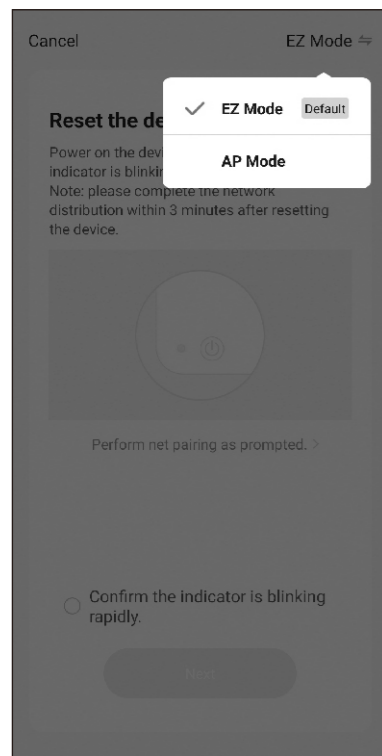

9.2.4 Click EZ mode at the upper right corner to change to AP mode.

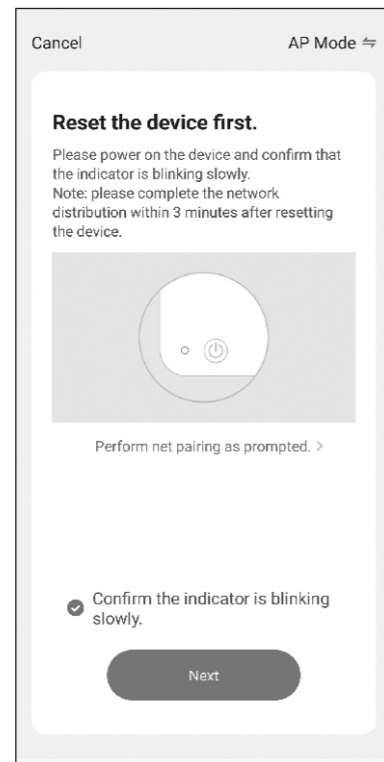

9.2.5 Long press the  button on the thermostat, hold it until  symbol flashes.

9.2.6 Click confirm and the next step.

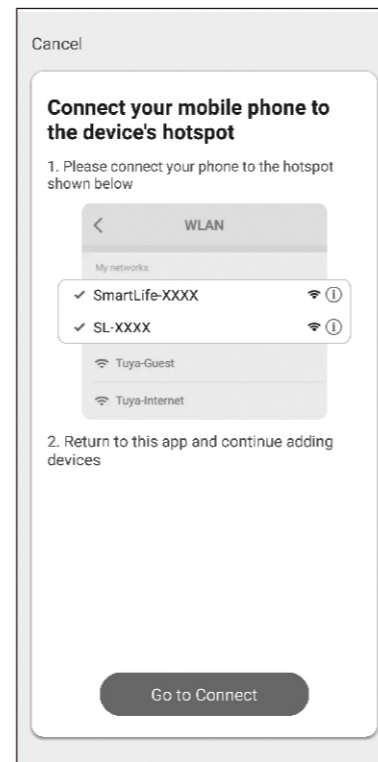

9.2.7 According to the hint click and connect it.

9.3 Description of the control interface



SET TEMPERATURE

CURRENT ROOM TEMPERATURE

MODE

WORKING CONDITION

POWER / FAN / MODE / SETTING

9.3.1 Set temperature:
Slide the circle to adjust the setting temperature.

9.3.2 Room temperature:
Indicate the current room temperature.

9.3.3 Working mode:
Click mode symbol to switch the corresponding working modes.

9.3.4 Working condition:
Indicate all the operation.

9.3.5 Power:
To turn on or turn off the power.

Fan mode:
To choose the fan mode is Auto or ON.

Run mode:
To choose the working mode is Manual or Program. Manual corresponds with Hold mode on the thermostat, and Program corresponds with Run mode.

Setting: Click setting to enter the interface.

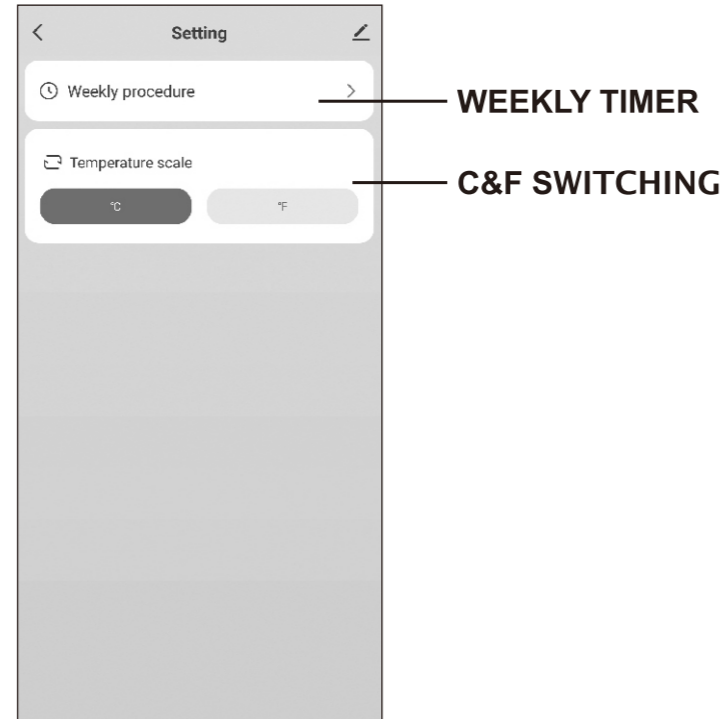

C & F switching: Click the temperature unit symbol.
Weekly timer: Click Weekly procedure to enter the setting.

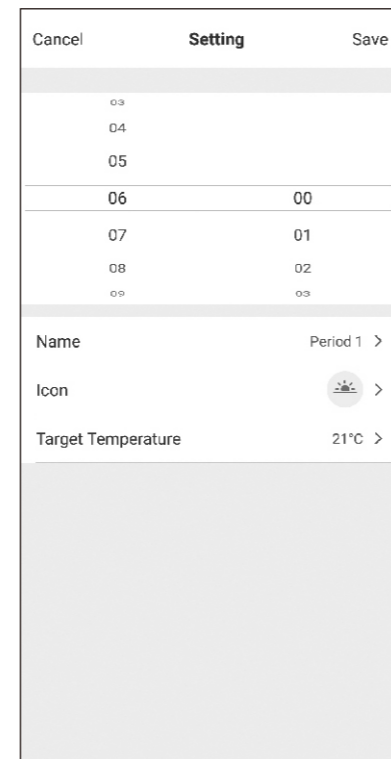
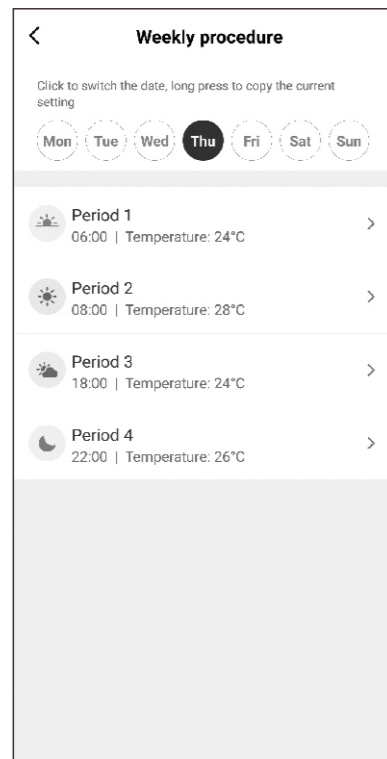

Weekly timer contains seven days a week, and four time periods. Included start time and temperature, click any one of them to enter the setting interface to set time, name, symbol, target temperature.

MOUNT THERMOSTAT

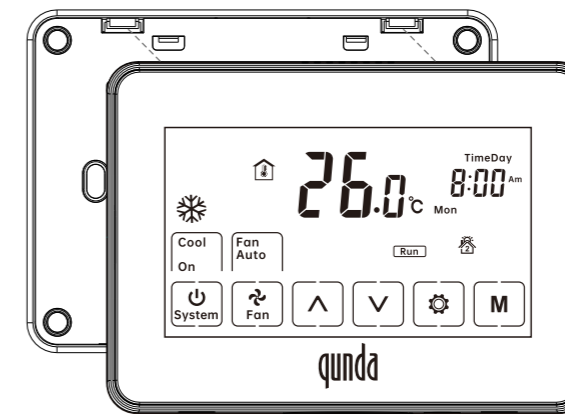

Step 1: Aim at the inner snaps in the higher part of the thermostat.

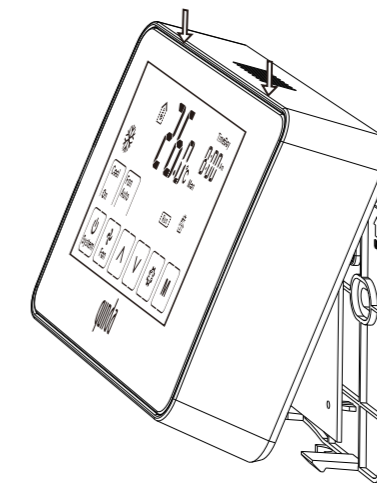

Step 2: Hang the two hooks of the front part at 30° right to the snaps.

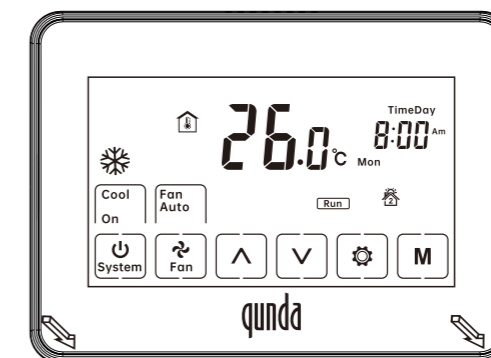

Step 3: Press the lower part of the front display panel to complete the installation.



In Step 3, if the user think it is hard to connect the pin, please move the display panel slightly. Then it will be work.